

Results from ALICE

Christine Nattrass

University of Tennessee at Knoxville

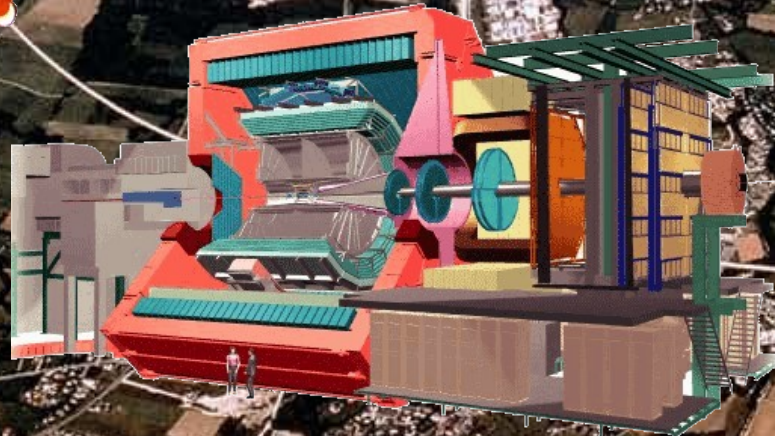
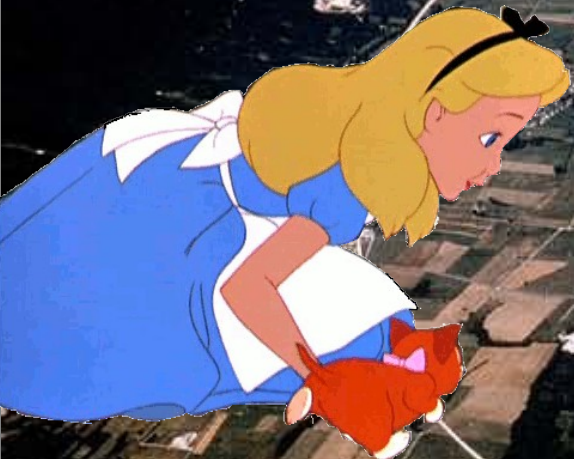

Phase diagram of nuclear matter

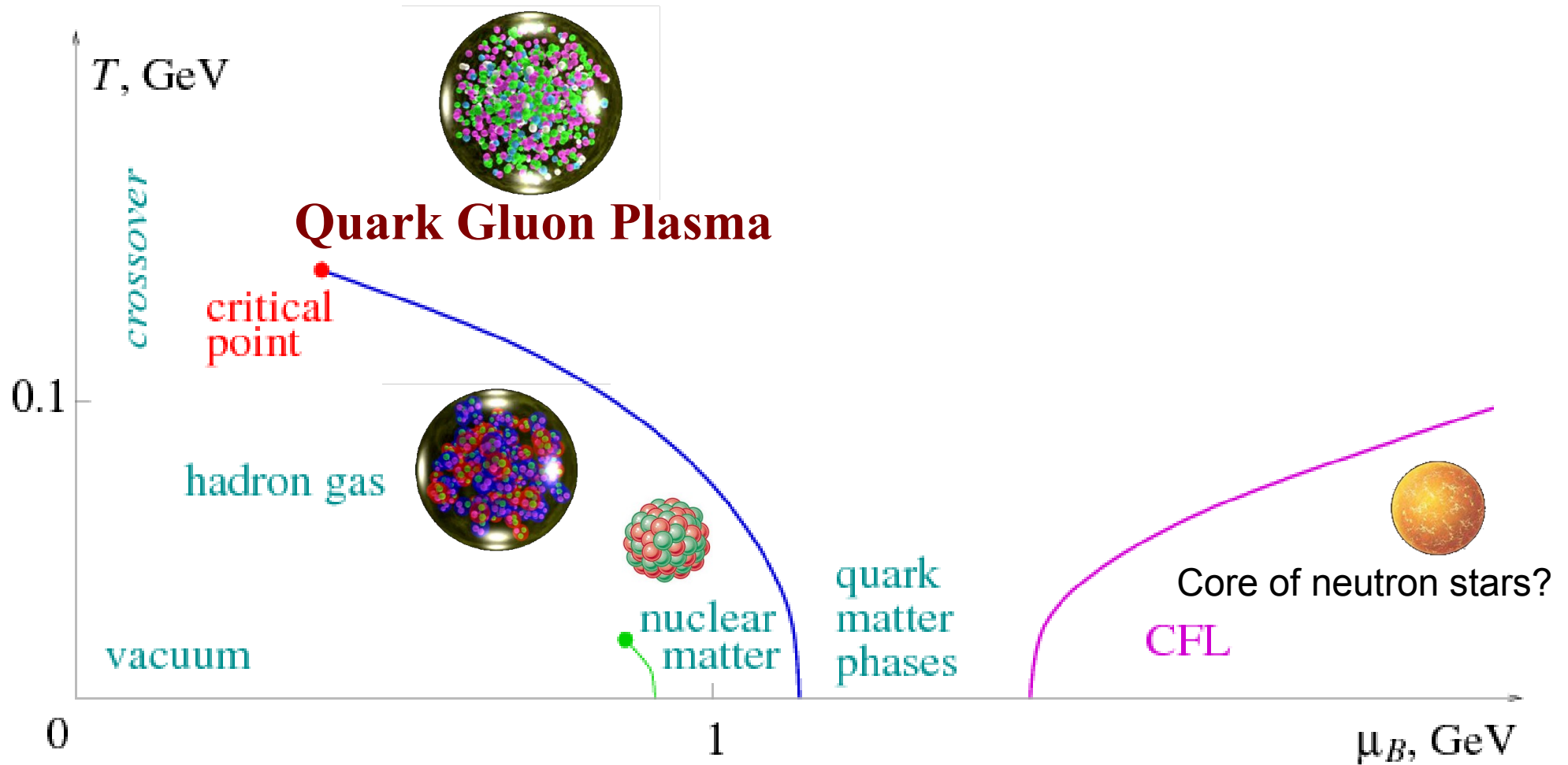

Quark Gluon Plasma – a *liquid* of quarks and gluons created at temperatures above ~ 170 MeV ($2 \cdot 10^{12}$ K) – over a million times hotter than the core of the sun



The phase transition in the laboratory

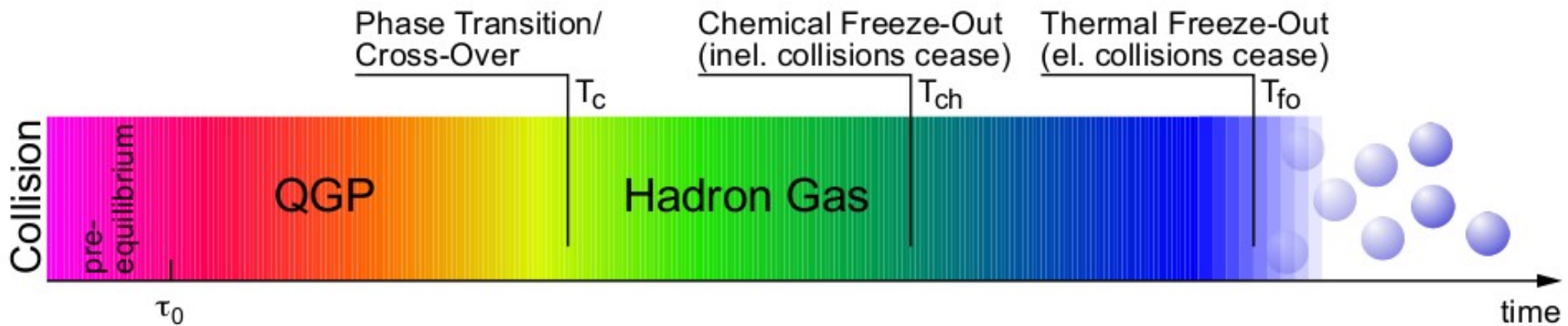
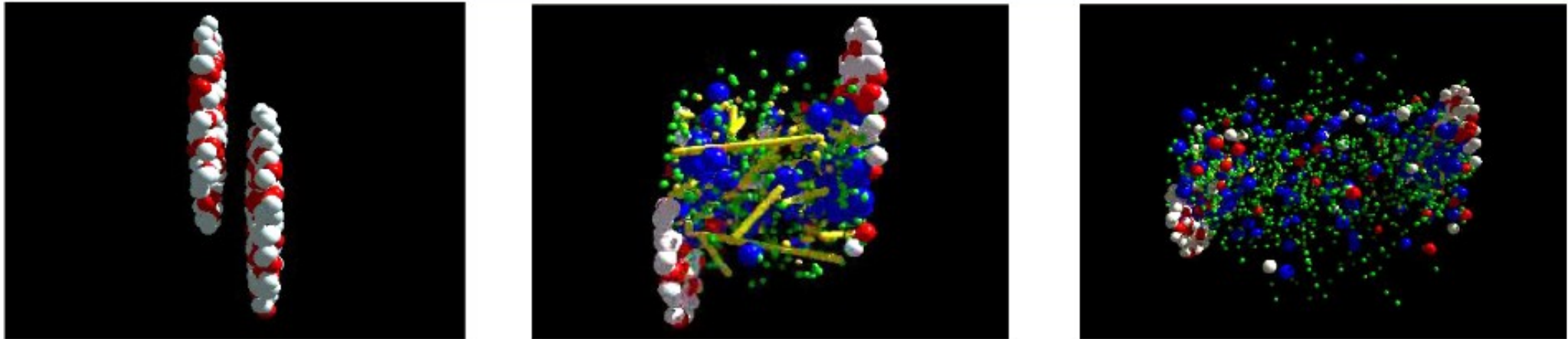

Size: 16 x 26 meters
Weight: 10,000 tons

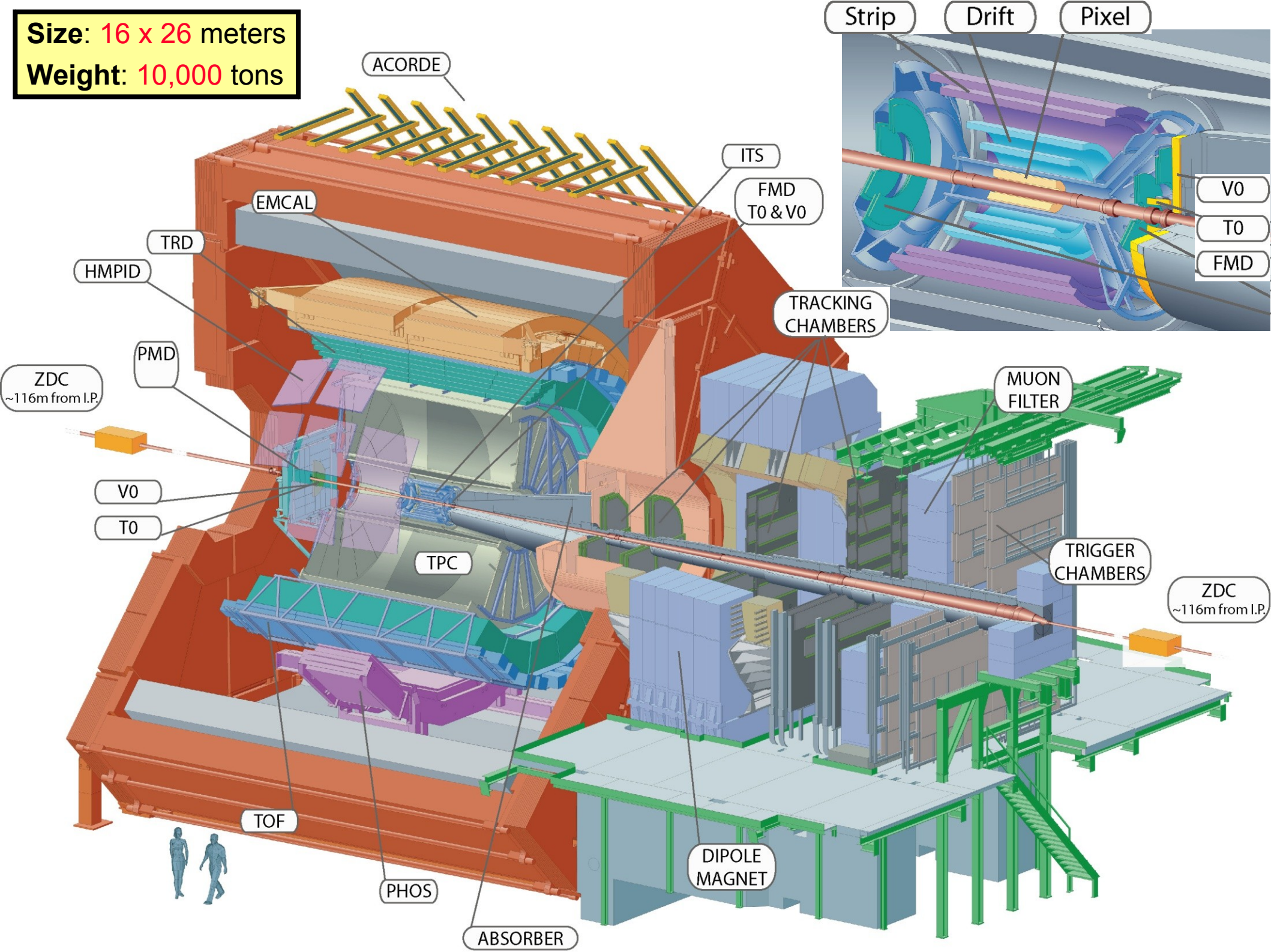

EMCal & DCal

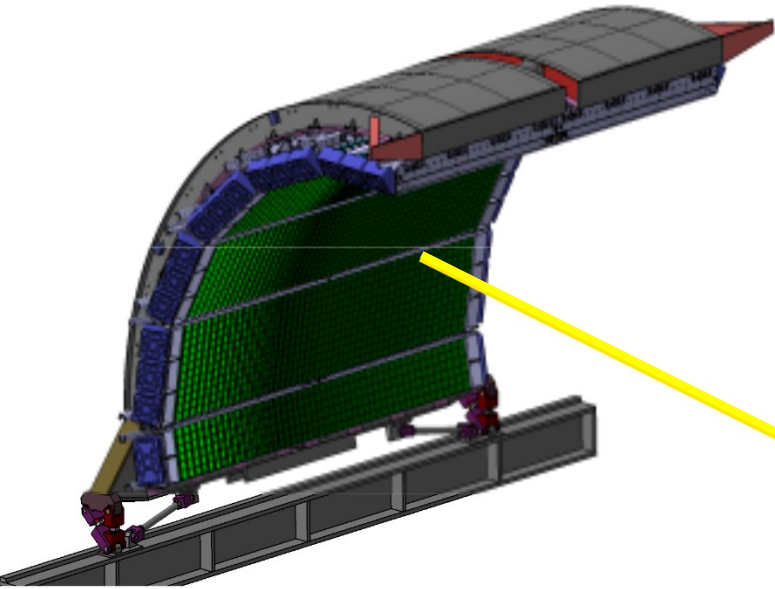

$$\Delta\eta=1.4, \Delta\phi=107^\circ$$

Installed in Fall 2014

$$\Delta\eta=1.4, \Delta\phi=60^\circ$$

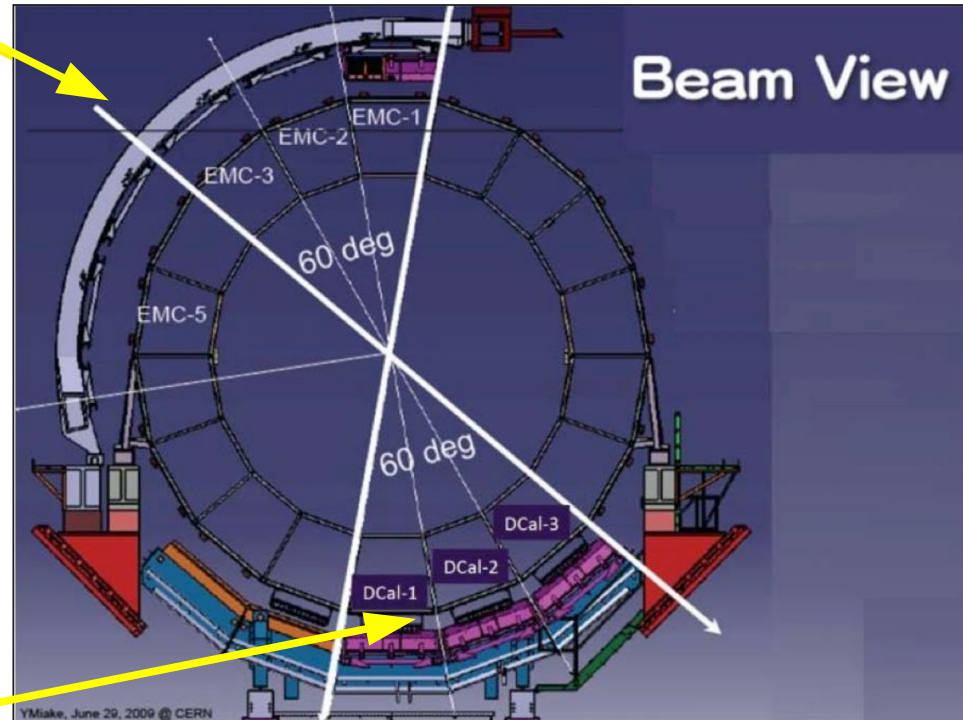
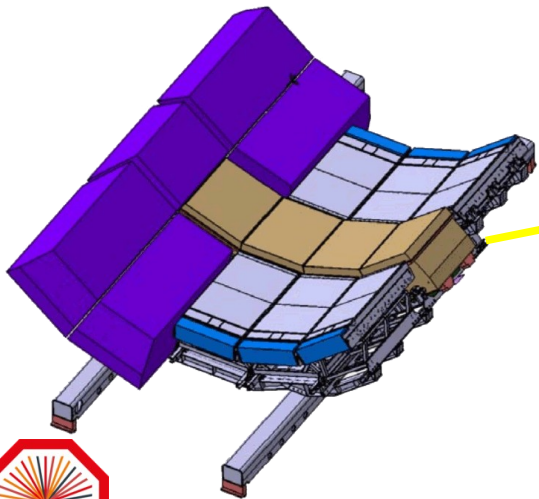

- Lead-scintillator sampling calorimeter
- 13 k towers
- Each tower $\Delta\eta \times \Delta\phi = 0.014 \times 0.014$
- $\sigma(E)/E = 0.12/\sqrt{E} + 0.02$



EMCal & DCal

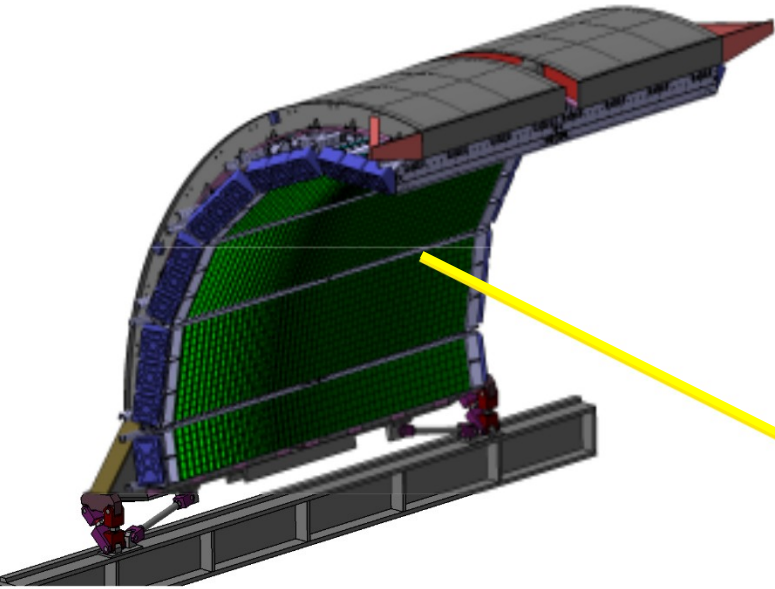

$\Delta\eta=1.4, \Delta\phi=107^\circ$

Installed in Fall 2014

$\Delta\eta=1.4, \Delta\phi=60^\circ$

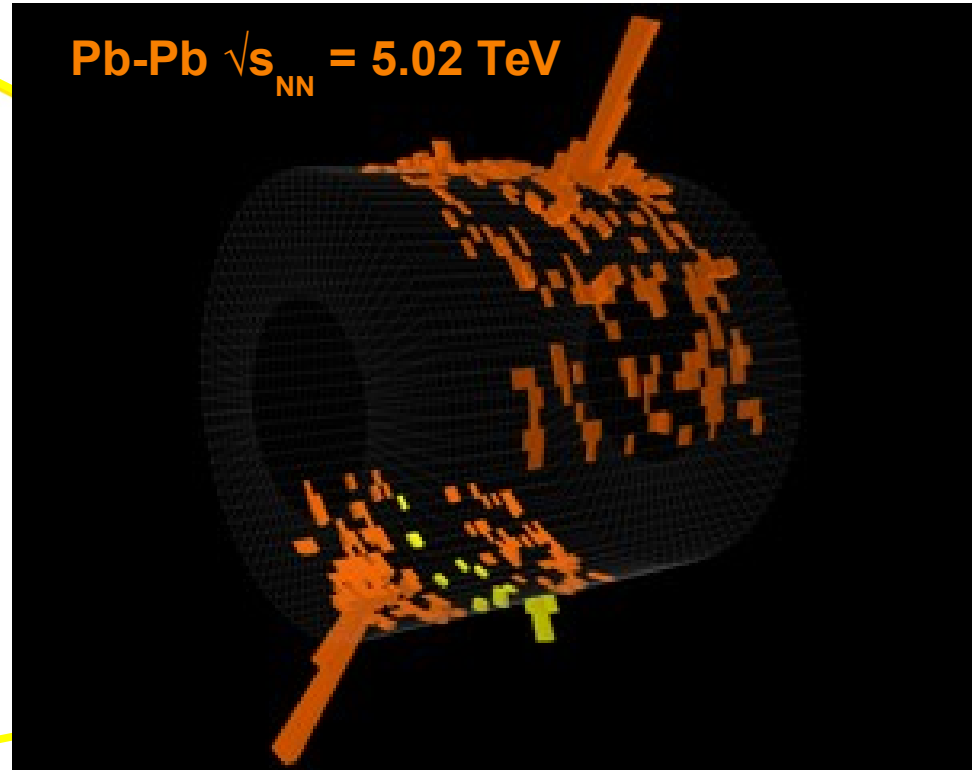
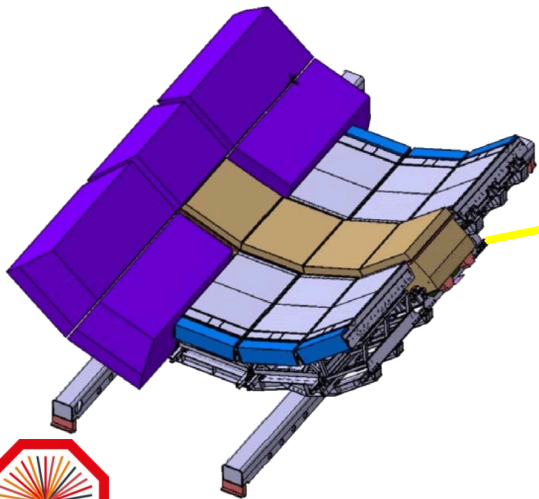

- Lead-scintillator sampling calorimeter
- 13 k towers
- Each tower $\Delta\eta \times \Delta\phi = 0.014 \times 0.014$
- $\sigma(E)/E = 0.12/\sqrt{E} + 0.02$



p+p collisions

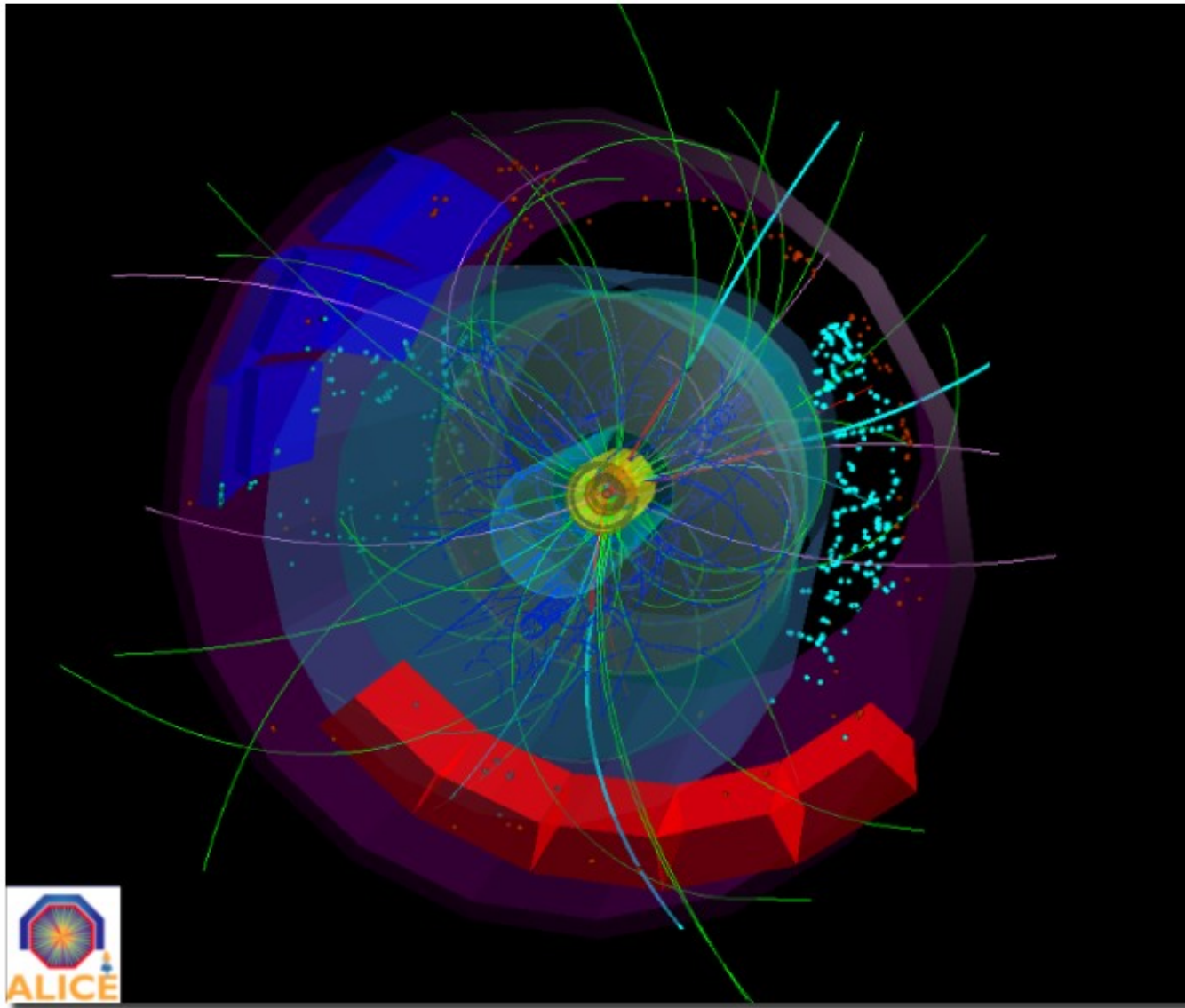

3D image of each collision



Pb+Pb collisions

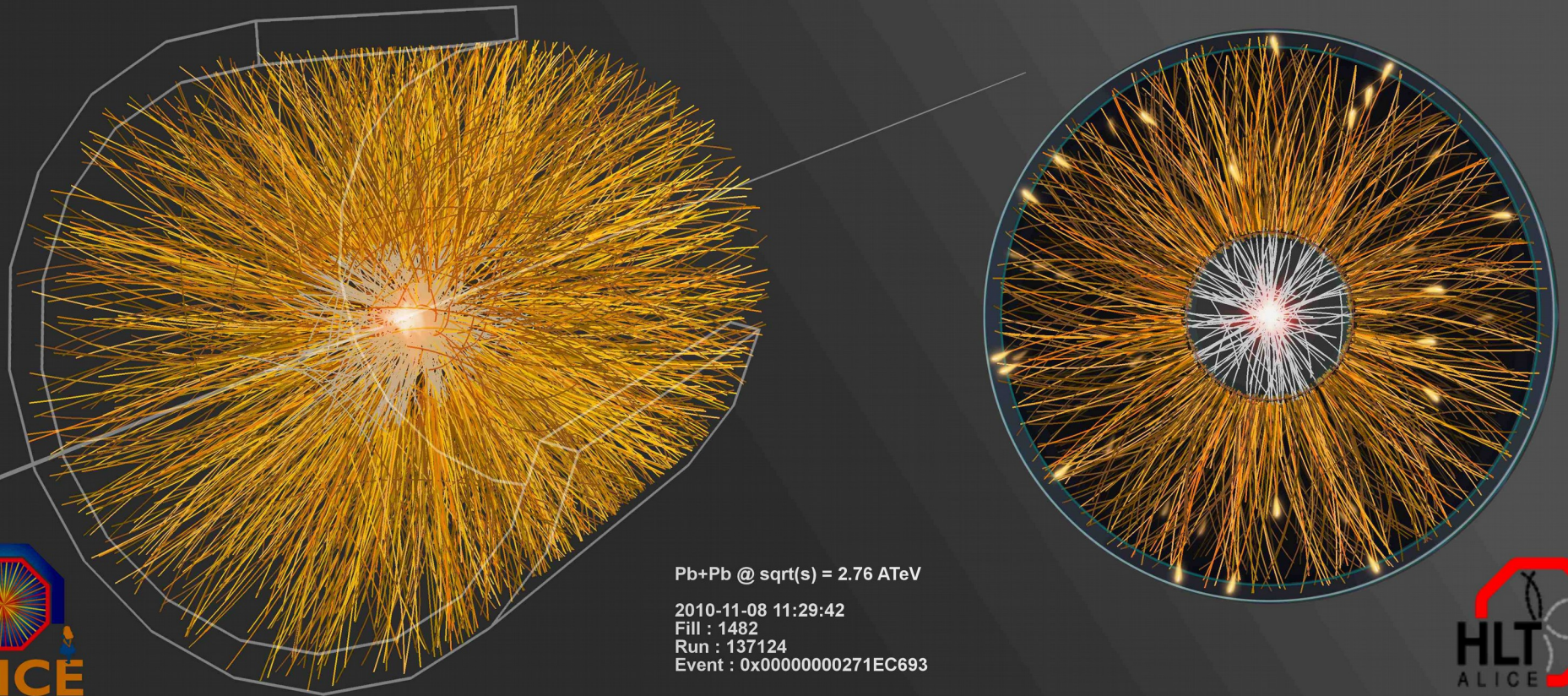

contactmiko@yahoo.de
agalkit3@gmail.com
NIKOS EMMANOULIDIS
AGEUKI MANTA



ALICE Performance

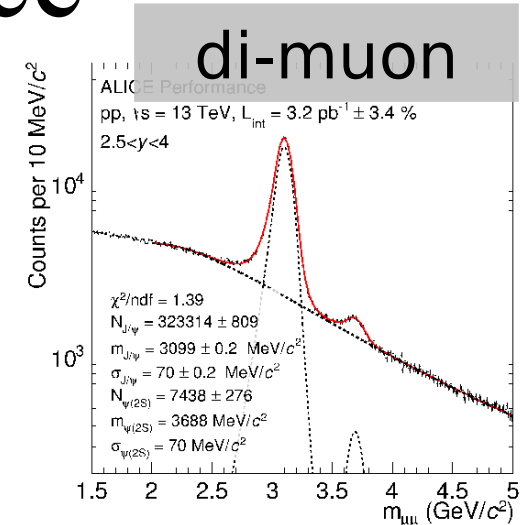
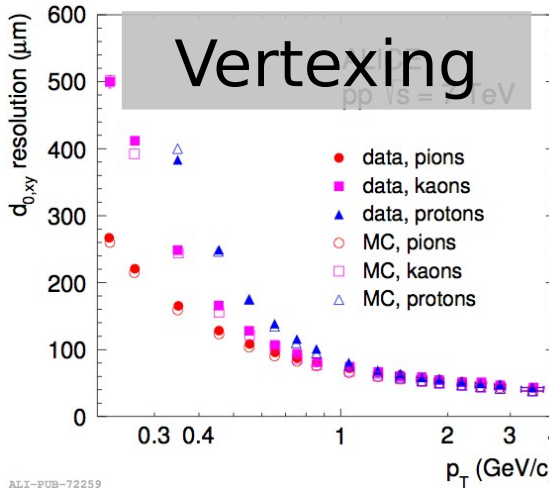
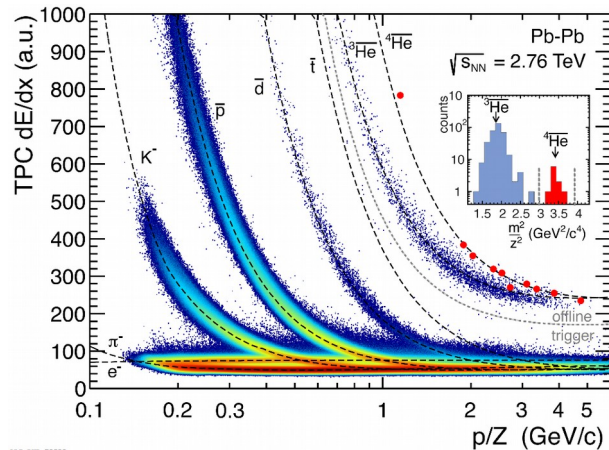

ALICE Int.J. Mod. Phys. A29 (2014) 1430044

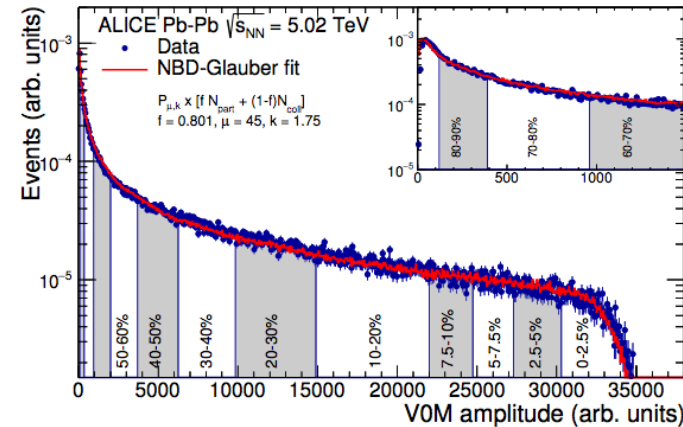
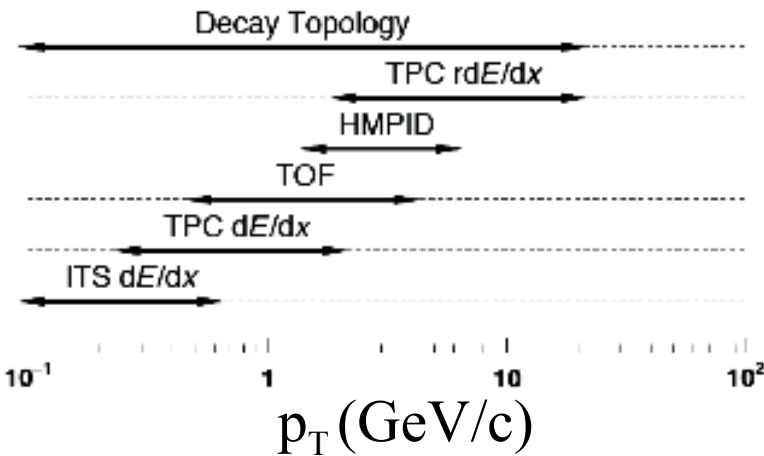

ALICE-PUBLIC-2015-008

- Low- p_T tracking: down to 150 MeV/c
- PID: anti- ${}^3\text{He}$ observed directly
- Vertexing capabilities: heavy flavors, V^0 , cascades, conversions



Data collection

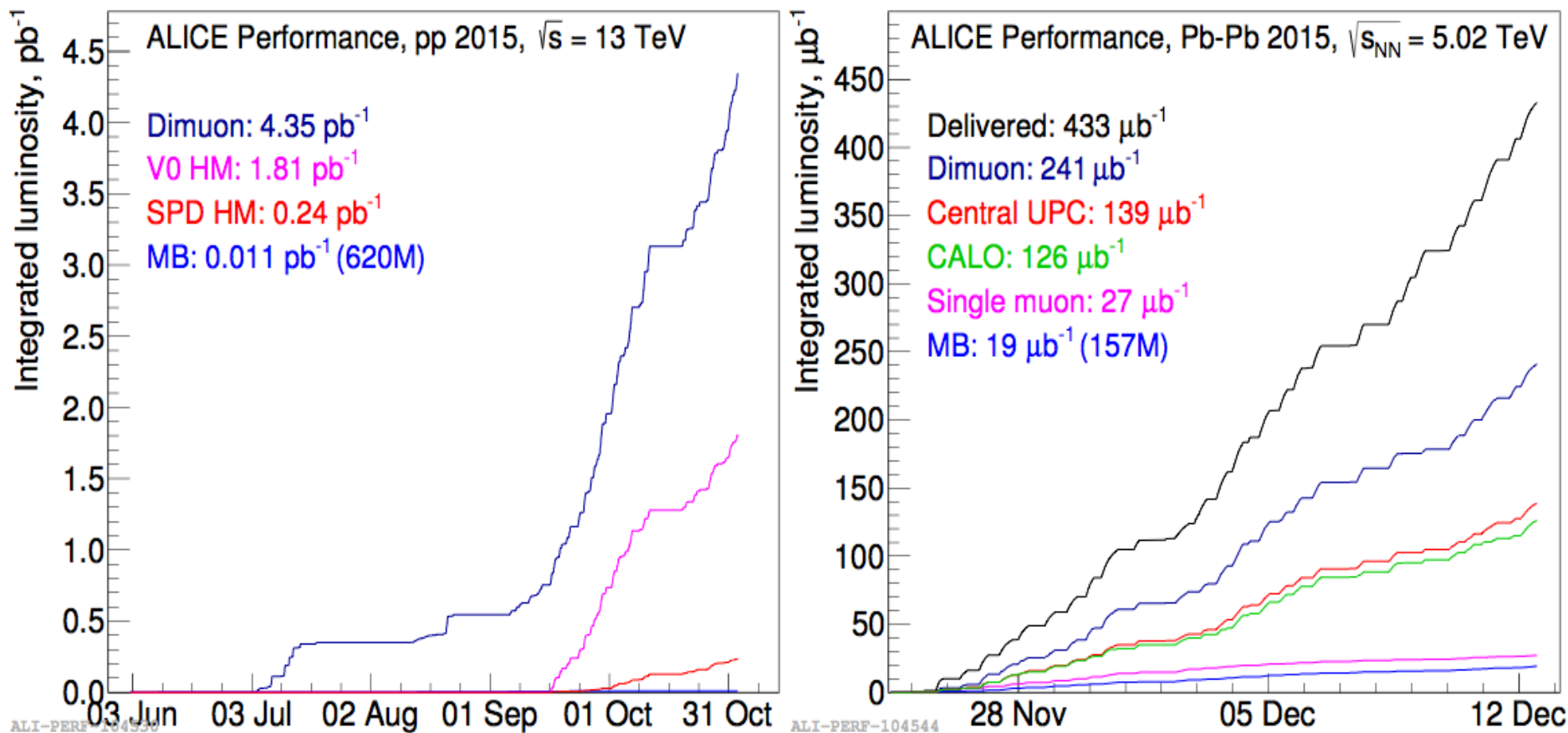

- Pb–Pb at 5.02 TeV: up to 0.5 nb^{-1}
- pp at 13 TeV and 4 days at 5.02 TeV ($\sim 100 \text{ nb}^{-1}$)
- Upcoming p–Pb at 5.02 and 8 TeV: 10 times more statistics than in RUN-I



Charged particle multiplicity

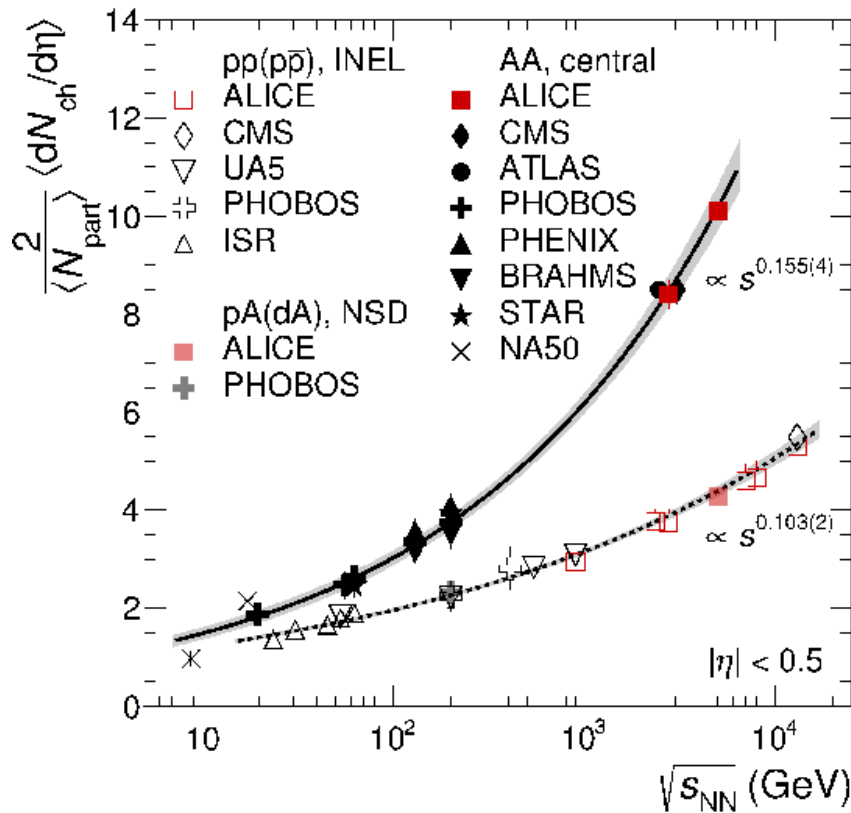

ALI-PUB-104920

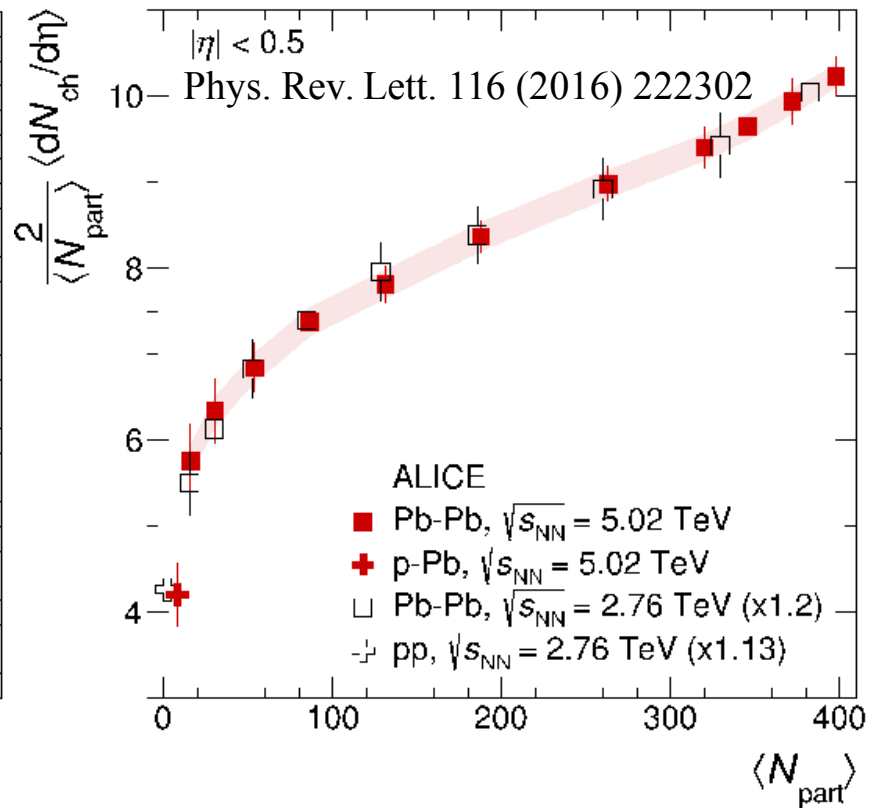

ALI-PUB-104924

- ALICE: Pb–Pb at 5.02 TeV — highest energy so far
 - For 0–5% most central collisions, confirms trend from lower energies
- $\langle dN_{ch}/d\eta \rangle$ vs. $\langle N_{part} \rangle$: similar evolution with centrality between 5.02 and 2.76 TeV
 - Provides further constraints for models
 - ~20% increase going from 2.76 to 5.02 TeV



Energy dependence from dE_T/dy

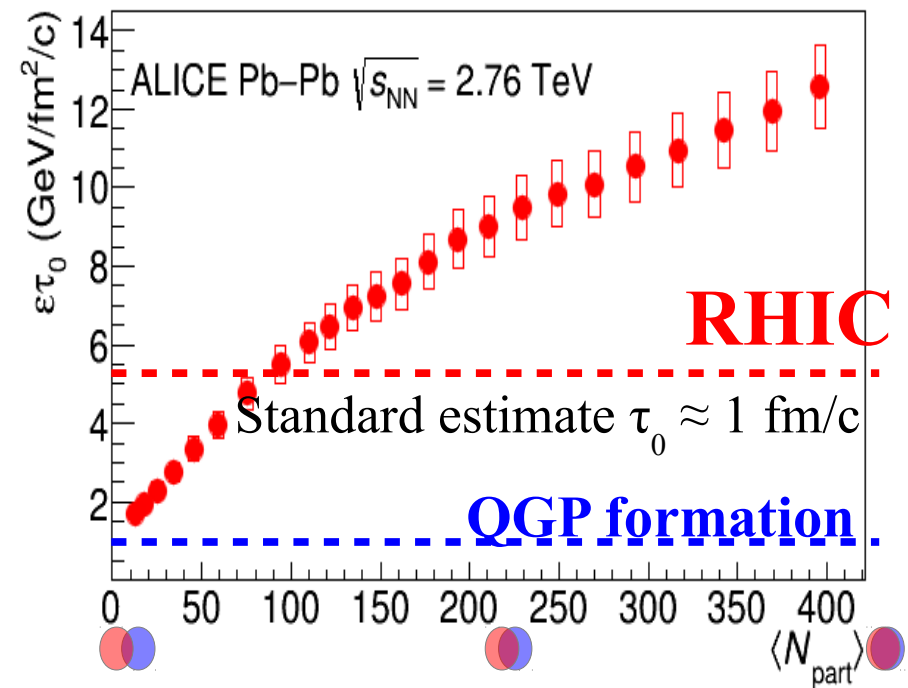
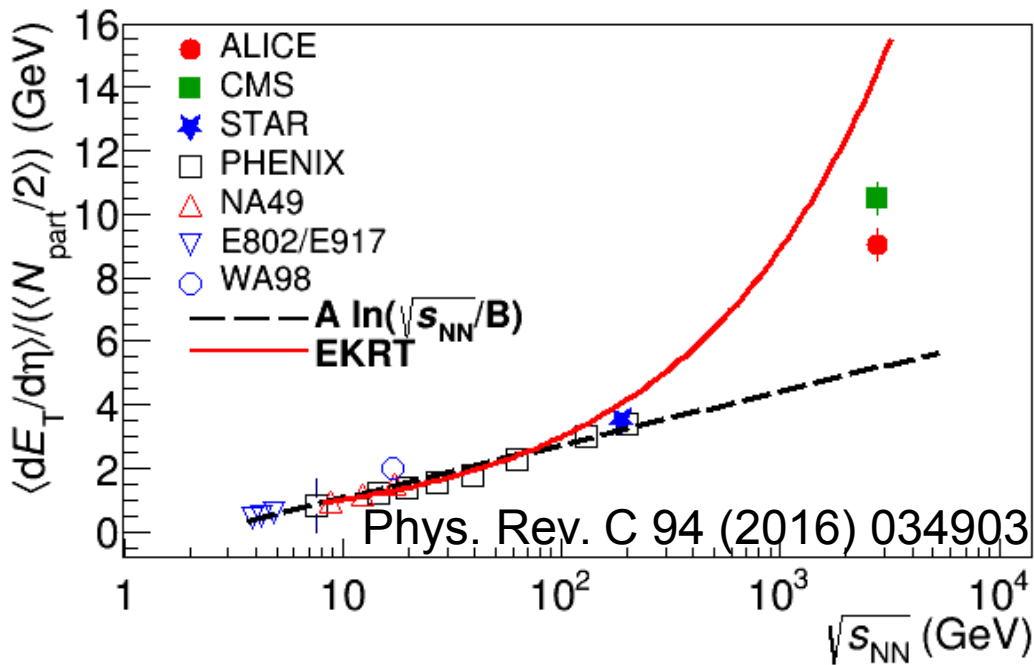

$$\epsilon = \frac{1}{Ac\tau_0} \frac{dE_T}{dy}$$

→ Higher than extrapolations of RHIC data



Direct photons in Pb-Pb collisions

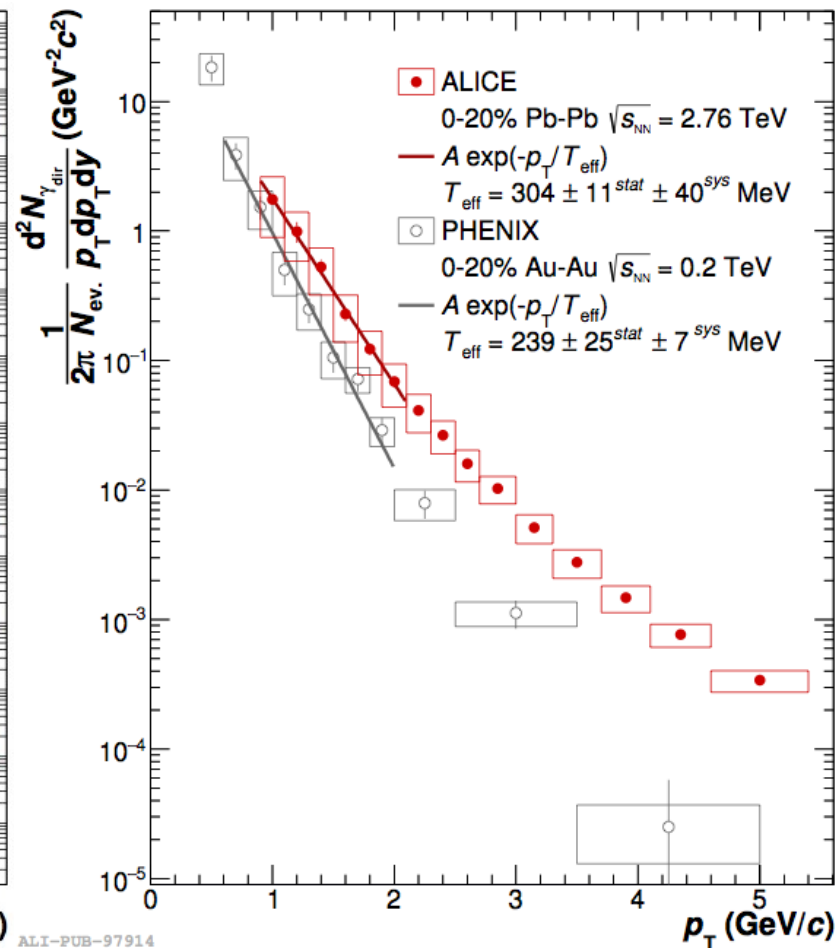
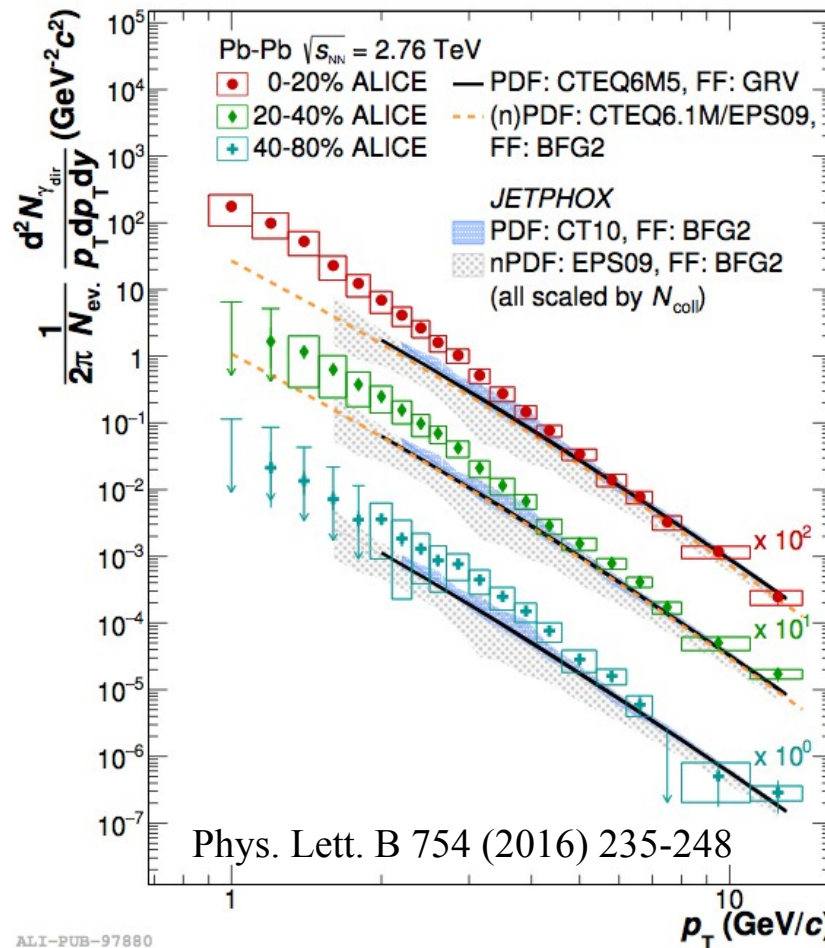

- Low- p_T : 2.6σ excess w. r. t. models in 0–20% central — thermal contribution
- $T_{eff} = 304 \pm 11(\text{stat.}) \pm 40(\text{syst.})$ MeV in central Pb–Pb collisions at 2.76 TeV
- 30% higher than at RHIC (Au–Au at $\sqrt{s_{NN}}=200$ GeV)



Relativistic fluids

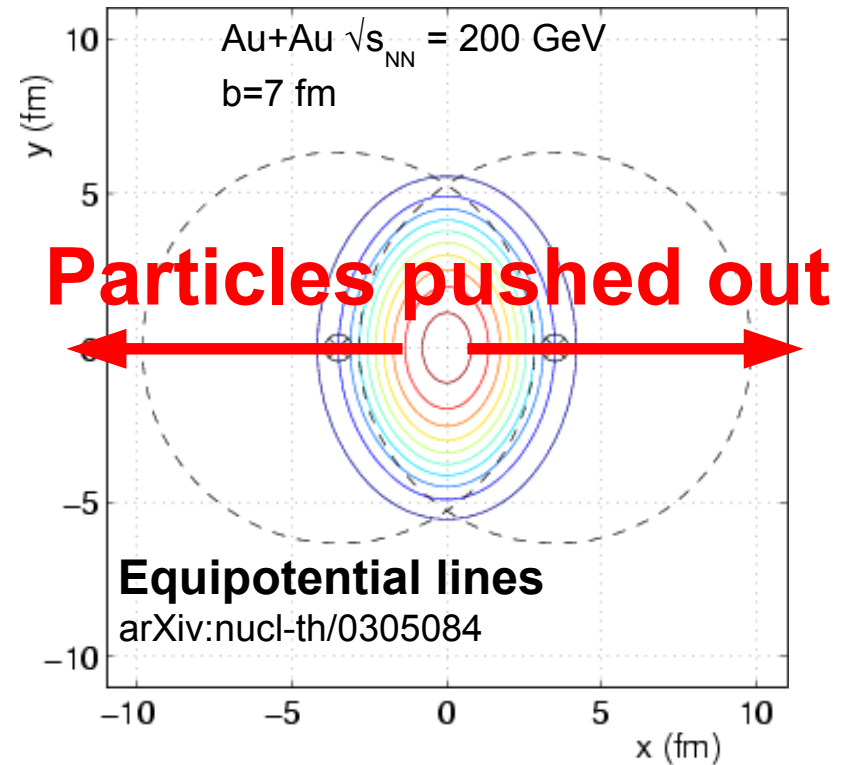
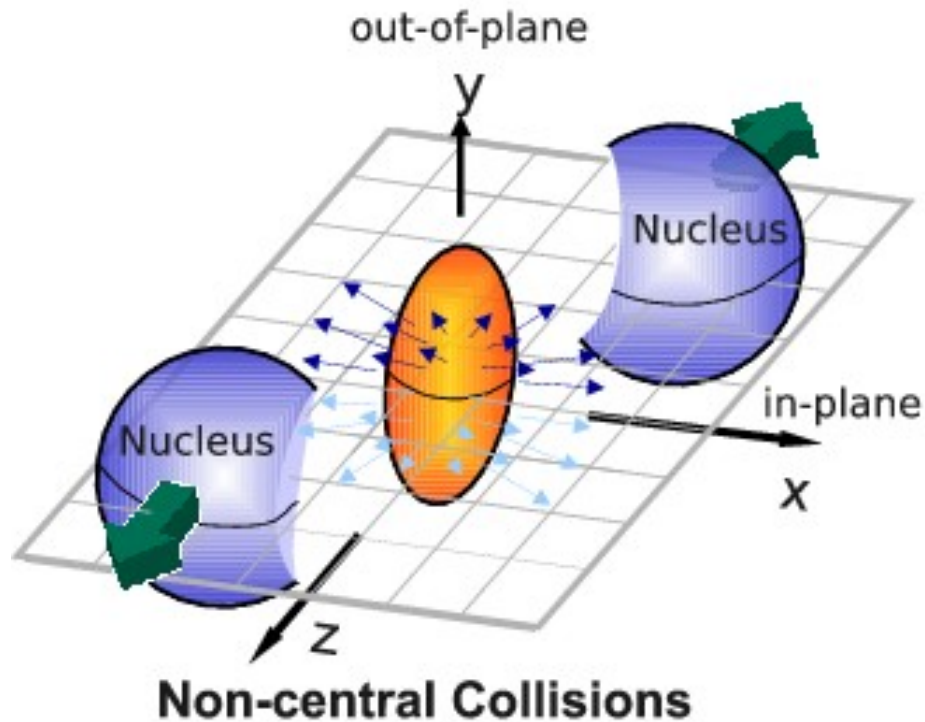

- Initial overlap asymmetric \rightarrow pressure gradients
- Momentum anisotropy \rightarrow Fourier decomposition:

$$\frac{d^2 N}{dp_T d\phi} \approx 1 + 2v_1 \cos(d\phi) + 2v_2 \cos(2d\phi) + 2v_3 \cos(3d\phi) + 2v_4 \cos(4d\phi) + 2v_5 \cos(5d\phi) + \dots$$



Ratio of v_n at different energies

Phys. Rev. Lett. 116 (2016) 132302

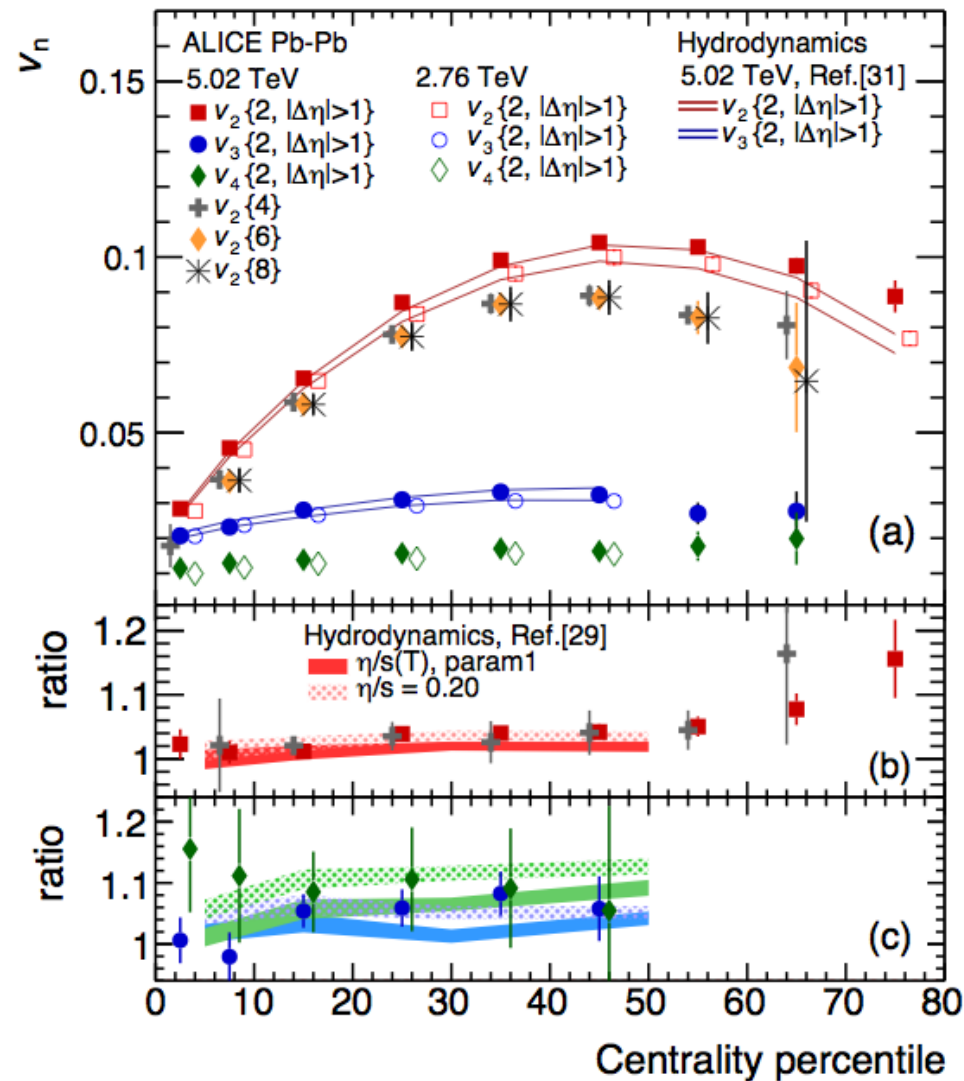

Charged particle R_{AA}

$$R_{AA} = \frac{d^2 N_{AA} / dp_T d\eta}{T_{AA} d^2 \sigma^{pp} / dp_T d\eta}$$

- $R_{AA} > 1$: enhancement
- $R_{AA} < 1$: suppression
- Strong modification of the spectrum shape in most central collisions
- Strong centrality dependence
- R_{AA} at 5.02 TeV similar to 2.76 TeV

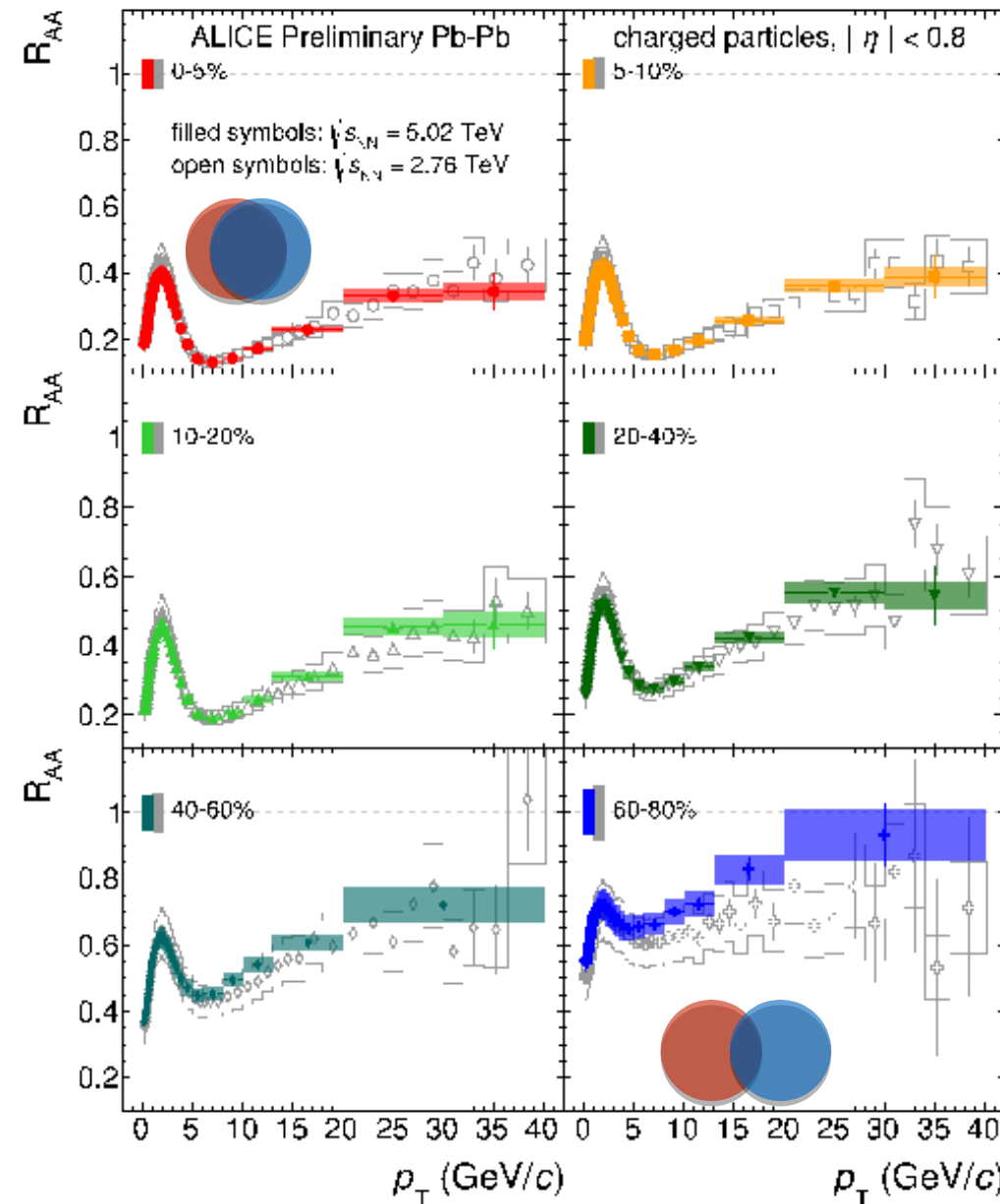

ALI-PREL-107300



Heavy-Flavor R_{AA}

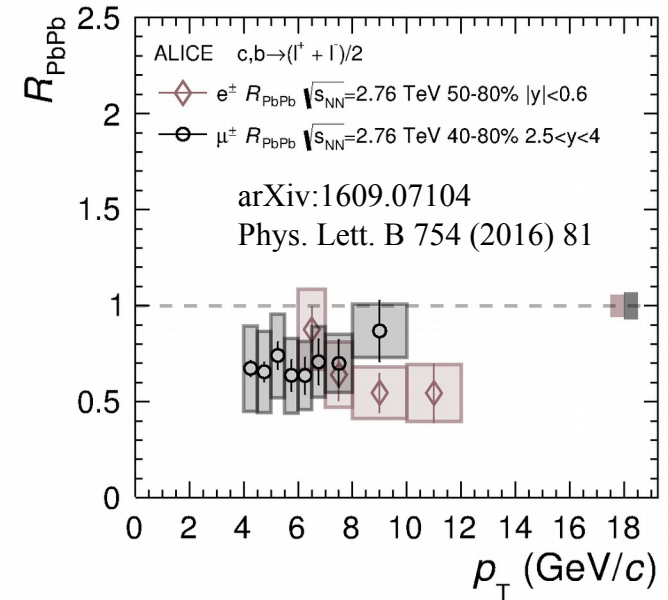
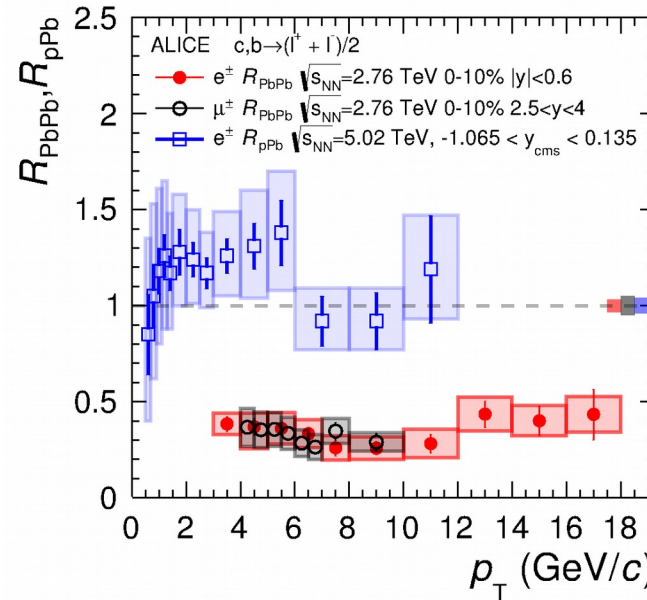
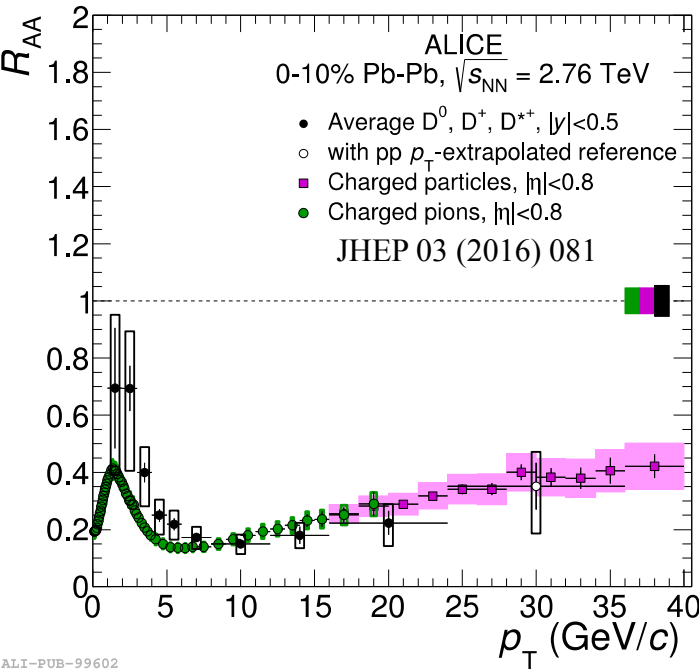

- Heavy flavor electron R_{pPb} consistent with unity for $p_T > 2$ GeV/c
- Large suppression at high p_T heavy quark in-medium energy loss
- $R_{AA}(D)$ and $R_{AA}(\pi)$ compatible with uncertainty at high p_T



Jet R_{AA}

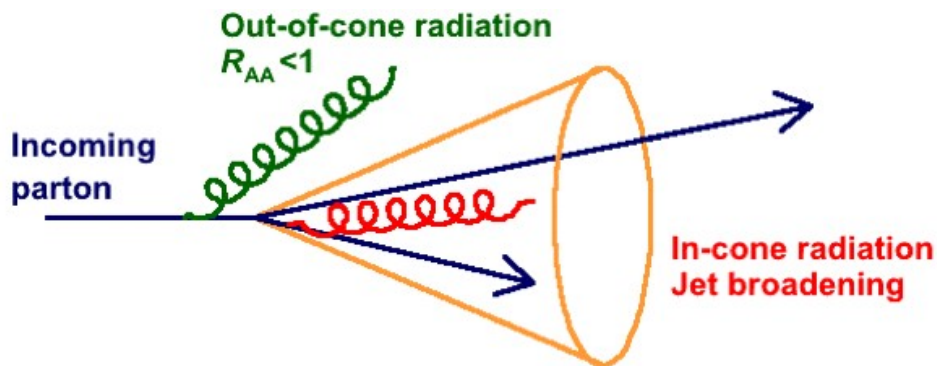

- Out-of-cone radiation: energy loss in jet cone
 - Jet yield suppression, di-jet energy imbalance, jet-jet/hadron-jet acoplanarity...
- In-cone radiation: medium modified fragmentation
 - Jet shape broadening, modification of transverse energy profile...
- Consistent with R_{AA} of charged particles and charged-jet R_{AA} at 2.76 TeV

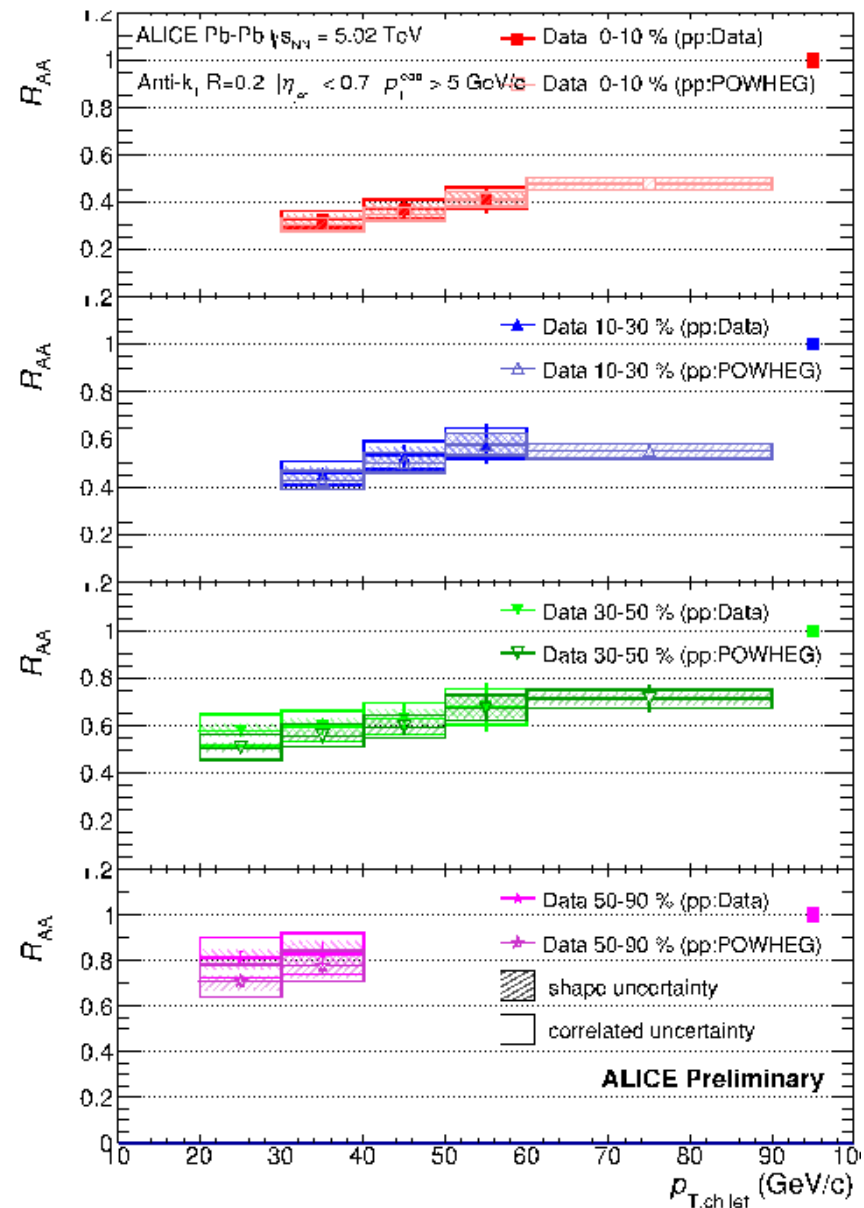

ALI-PREL-113513

$$R_{AA} = \frac{d^2 N_{AA} / dp_T d\eta}{T_{AA} d^2 \sigma^{pp} / dp_T d\eta}$$



Hadronic Phase

- Reconstructible resonance yields may be changed by **hadronic scattering processes** after chemical freeze-out:
 - **Regeneration:** **pseudo-elastic scattering** of decay products
 - **Re-scattering:**
 - Resonance **decay products** undergo elastic **scattering**
 - Or pseudo-elastic scattering **through a different resonance** (e.g. ρ)
 - Resonance **not reconstructed** through invariant mass

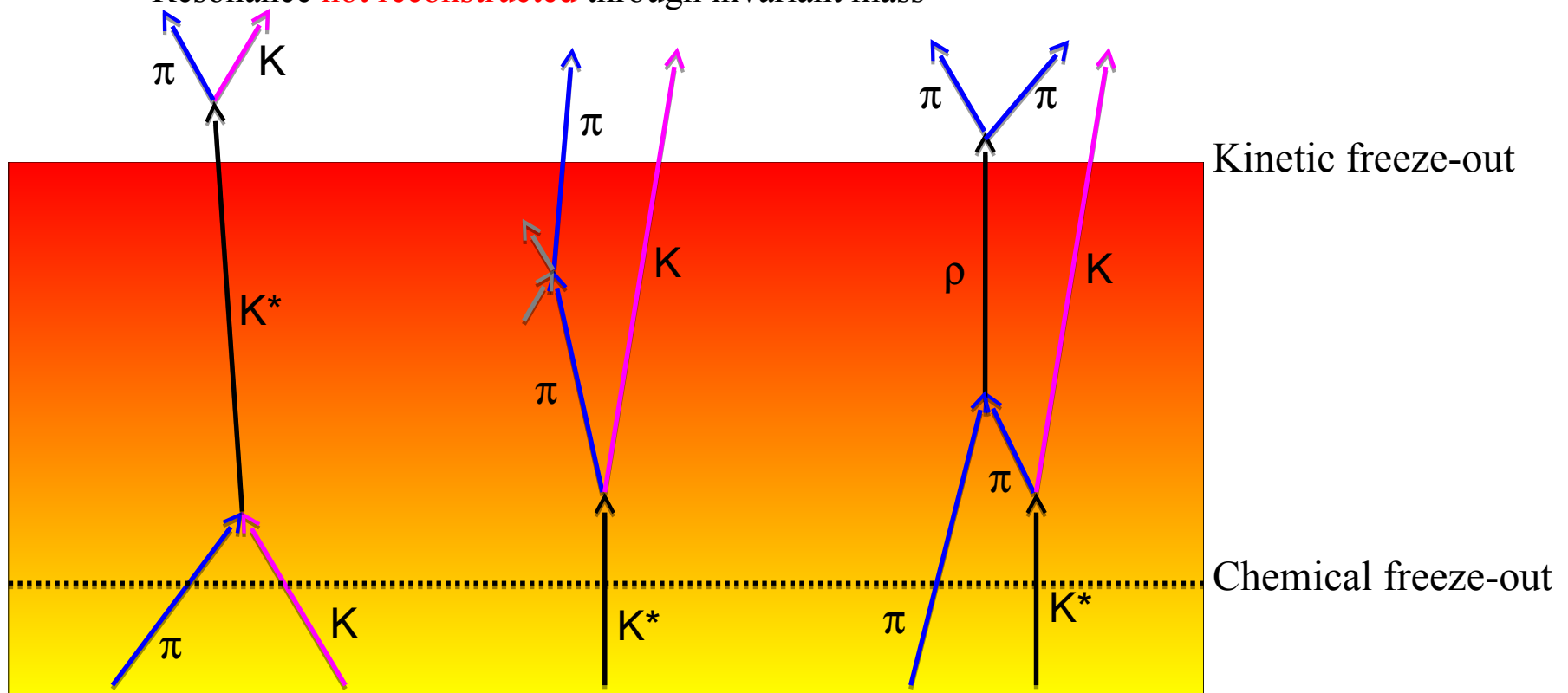

Other Resonances

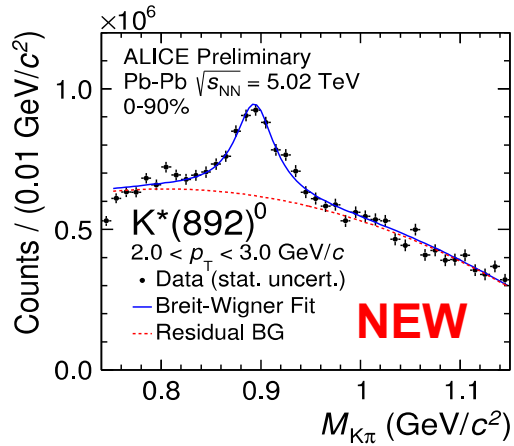
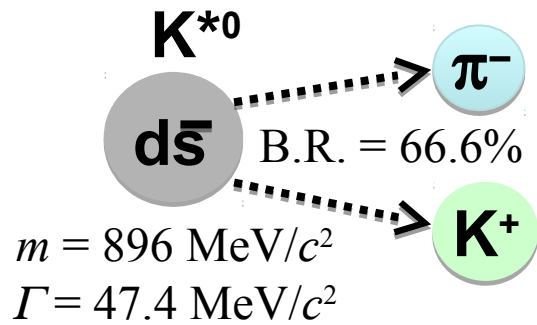

ALI-PREL-107486

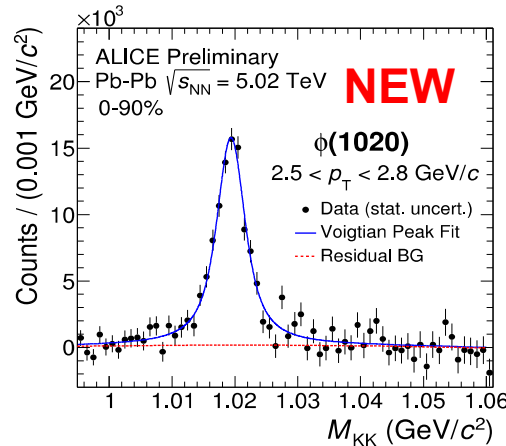
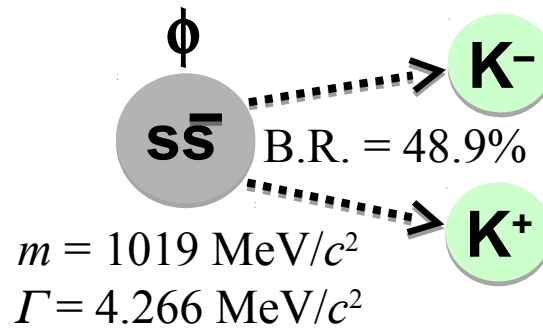

ALI-PREL-107446

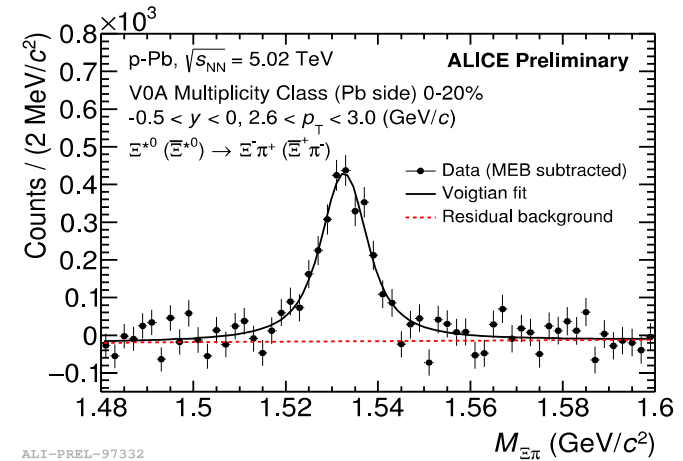
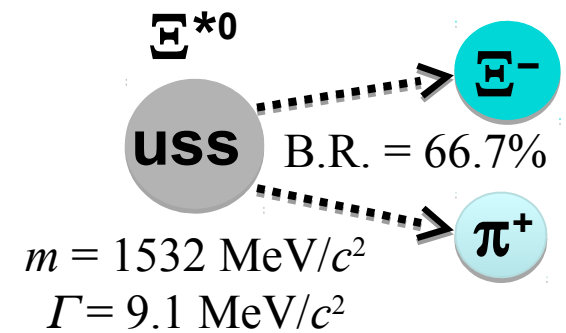

ALI-PREL-97332

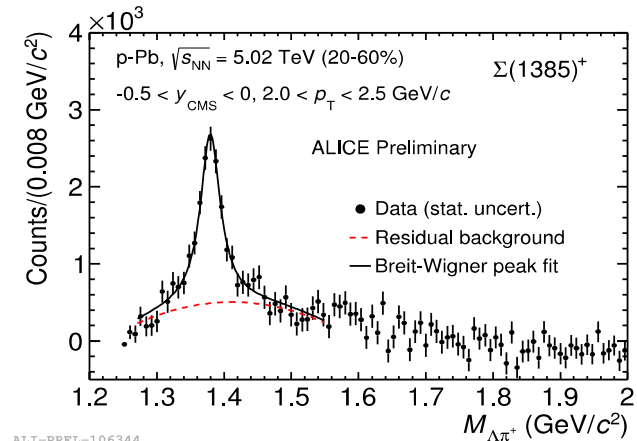
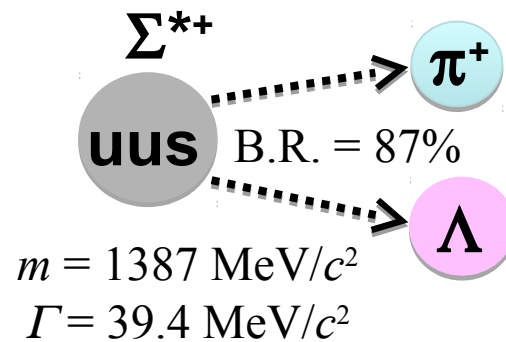
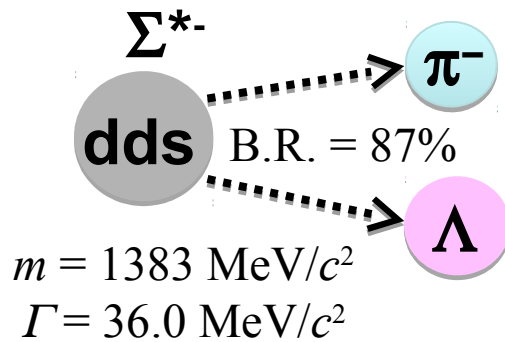

ALI-PREL-106344



Ratios to Stable Hadrons

- **Suppression of ρ^0/p and K^{*0}/K in central Pb–Pb w.r.t. peripheral, pp, p–Pb, thermal model**
 - Suggests that **re-scattering is dominant** over regeneration
 - Well described by EPOS+UrQMD
- K^{*0}/K in small systems:
 - decreasing trend observed in **p–Pb** (slope not consistent with 0)
 - Multiplicity-dependent **suppression in pp**
- No suppression of ϕ/K , no strong centrality dependence
 - Central **Pb–Pb** consistent w/ thermal model
 - Lifetime of $\phi \sim 10\times$ longer than K^{*0} , $\sim 35\times$ longer than ρ^0 , re-scattering effects not significant
 - Ratio in **p–Pb** consistent with trend from pp to peripheral **Pb–Pb**

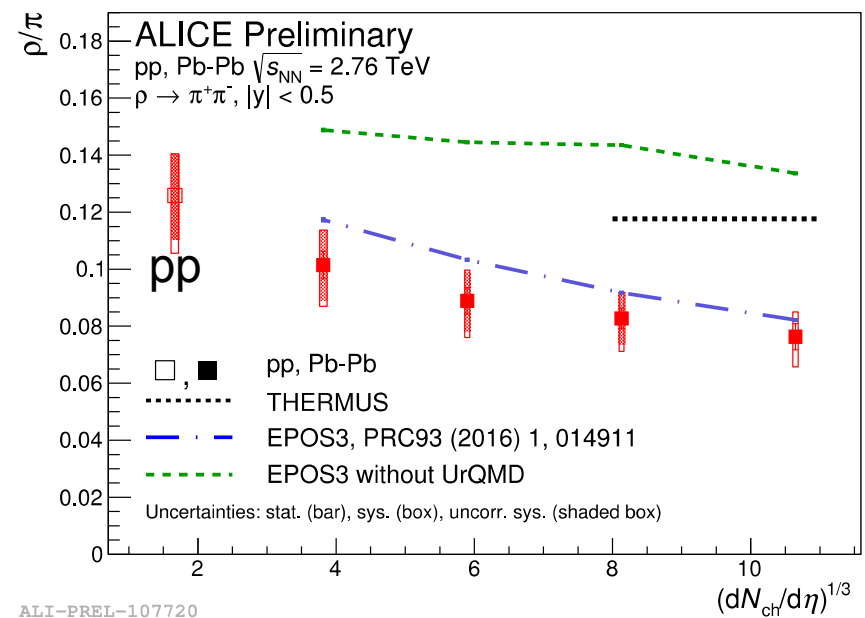

ALI-PREL-107720

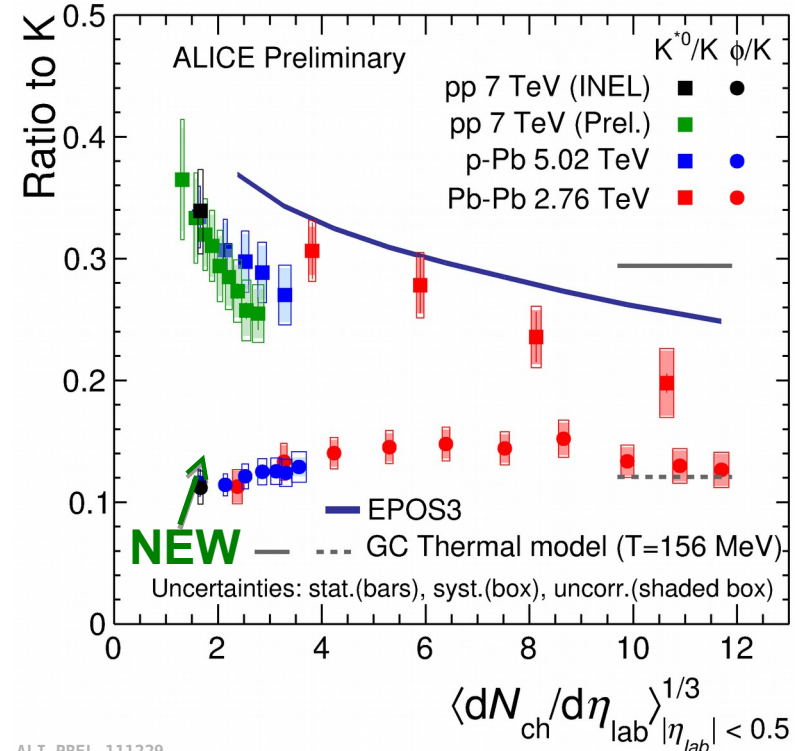

ALI-PREL-111229

Phys. Rev. C **91** 024609 (2015)
Eur. Phys. J. C **76** 245 (2016)



Jet mass and virtuality

$$M = \sqrt{p^2 - p_T^2 - p_z^2} \quad p = \sum_{i=1}^n p_{T_i} \cosh \eta_i \quad p_z = \sum_{i=1}^n p_{T_i} \sinh \eta_i$$

- Jet mass increases with the radial distance of the constituents from the jet axis
 - Soft constituents, away from the jet axis within the cone \rightarrow larger mass
 - Few hard constituents \rightarrow smaller mass
- \rightarrow E.g. gluon vs quark jets jet mass difference

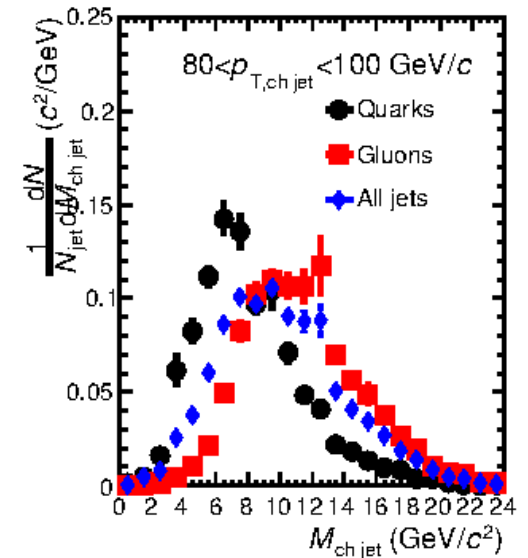

Comparison to models

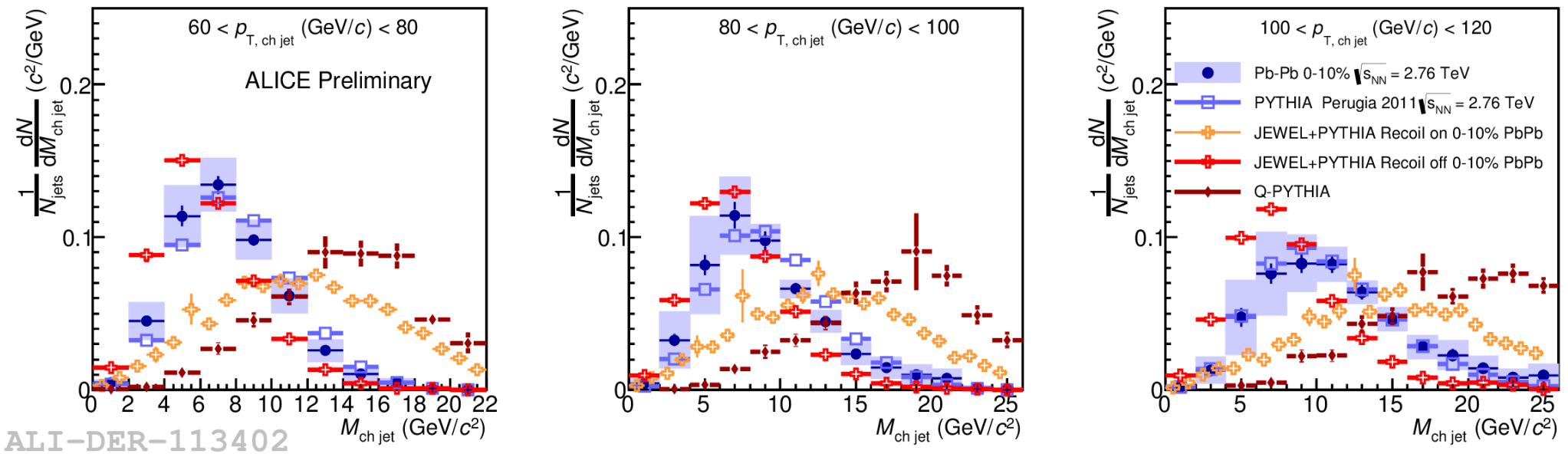

- Quenching models (**JEWEL**, **Q-PYTHIA**) show a larger mass than pp-like **PYTHIA** jets
 - JEWEL: 2→2 pQCD matrix elements with parton shower taking into account radiation. For charged jets the background subtraction is implemented by shifting the distribution considering the background estimated for full jets and the difference between full and charged jets in pp
 - Q-PYTHIA: PYTHIA with medium effects in the final state branching through an additive term in the splitting functions computed in the multiple-soft scattering approximation
- JEWEL with “recoil off” (removing recoil centres before hadronization) shows a depletion of the jet mass wrt pp due to less low- p_T fragments wrt recoil on
- Pb-Pb measurement can discriminate among these predictions



Conclusions

- Precision tracking and PID enable precision measurements of
 - Global observables (N_{ch} , E_T)
 - Direct photons
 - Hydrodynamical flow
 - Jets
 - Resonances
- More to come!
 - Results from DCal
 - Upgrades for run 3

